

## Smart Car -- 2WD

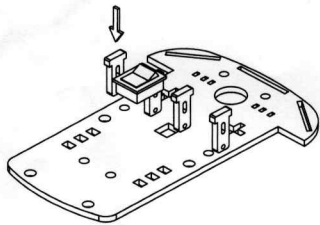

Setp1:Insert the fastener into the chassis after tearing off the yellow protection wrap of the chassis,the fastener and the code wheel.

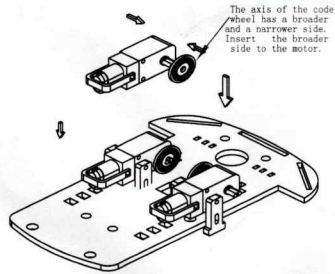

Setp2:Install the code wheel and fix the motor to the chassis. (Attention,the copper sheet of the leading wire of the motor should face outward,the same side of the wheel)

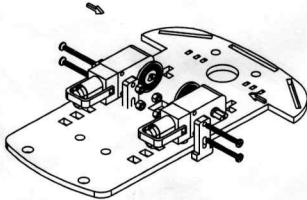

Setp3:Fix the motor to the chassis,then insert and tighten the screws.

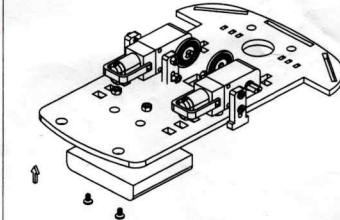

Setp4:Insert the screws and fix the battery container.

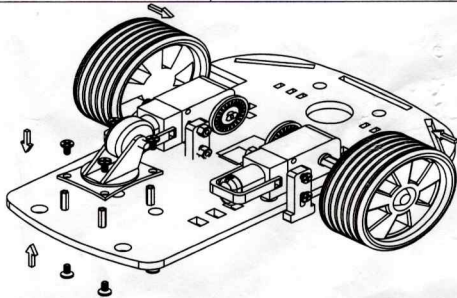

Setp5:Insert the spacer and tighten the 8 screws to fix the hammer caster. Hold tight and insert the motor(protection fastener) to the wheel.Installation completed.

## Smart Car -- 2WD

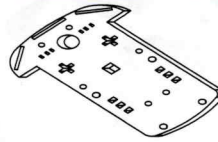

Chassis 1 pcs



Wheel 2 pcs



Velocimetry code wheel 2 pcs

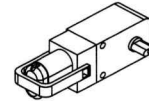

DC Gear Motor 2 pcs

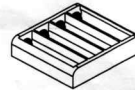

Battery container 1 pcs

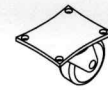

Universal wheel 1 pcs



M3\*8 Screw 2 bars



M3 nut 6 pcs



M3\*6 Screw 8 bars



L10 Spacer 4 bars



M3\*30 Screw 4 bars



Switch 1 pcs



Fastener 4 pcs

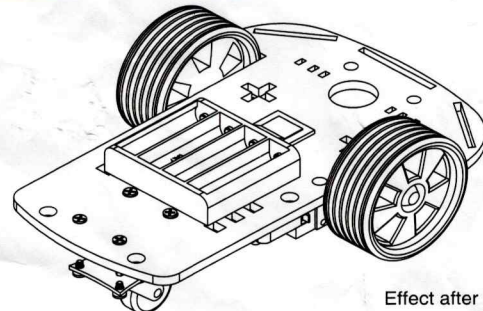

Effect after installation